

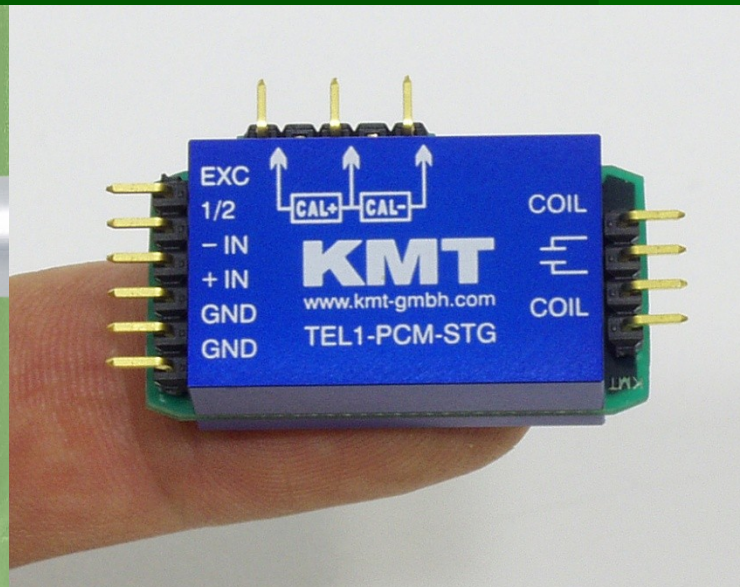

Telemetry Application Examples

TEL1-PCM

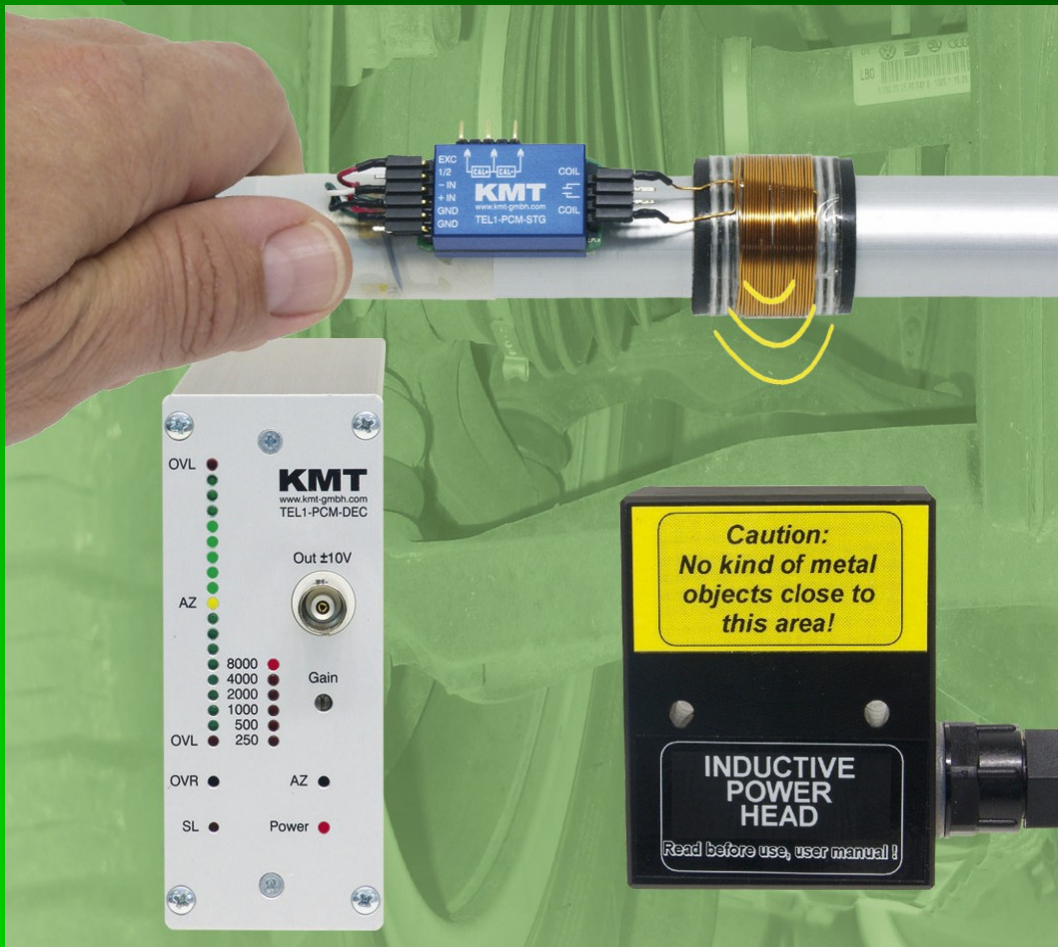

Telemetry Application Examples

TEL1-PCM

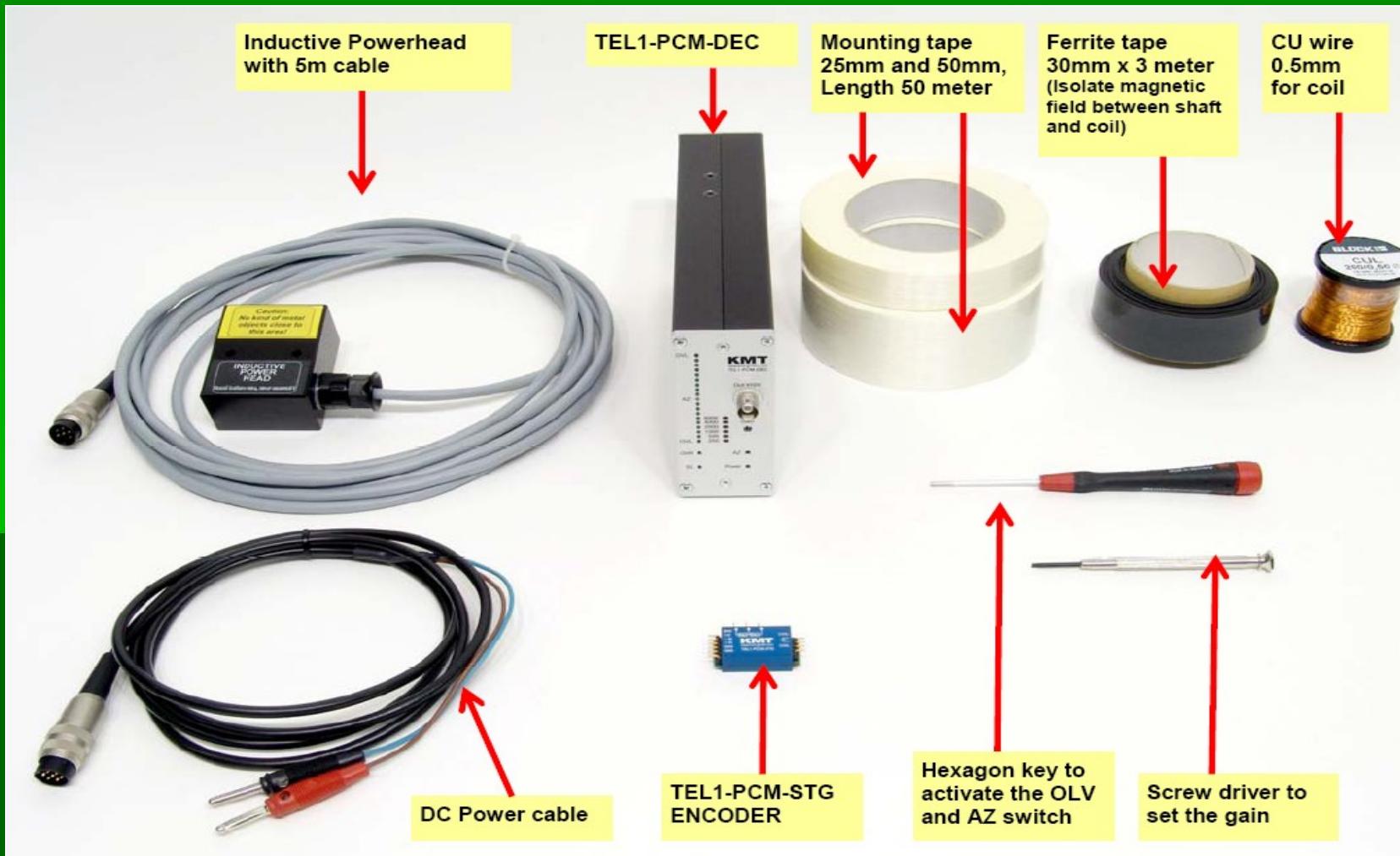

Telemetry Application Examples

TEL1-PCM

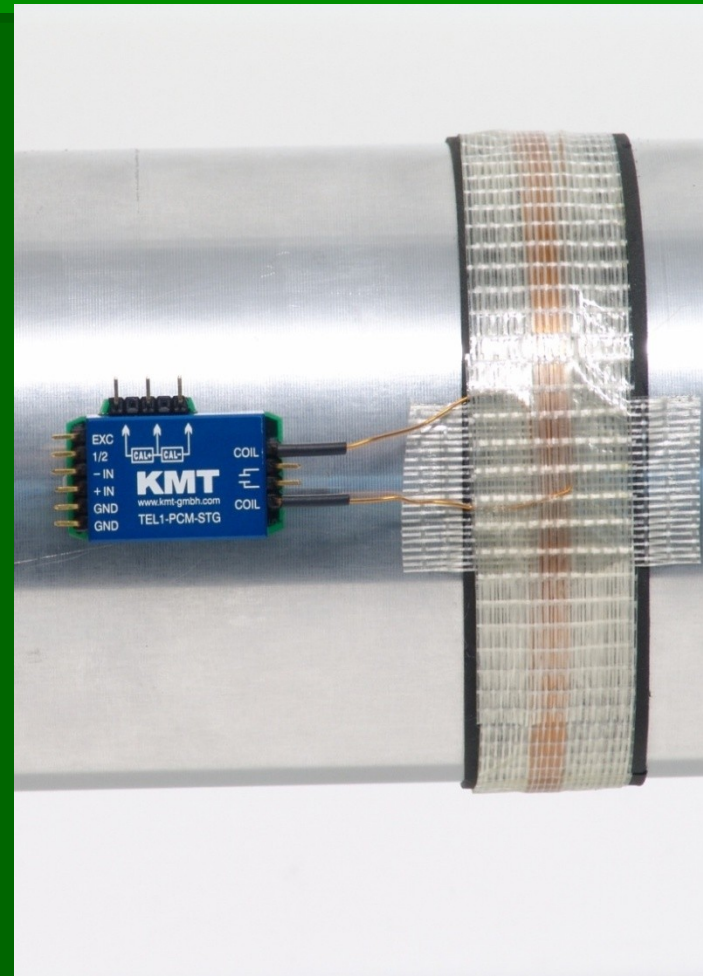
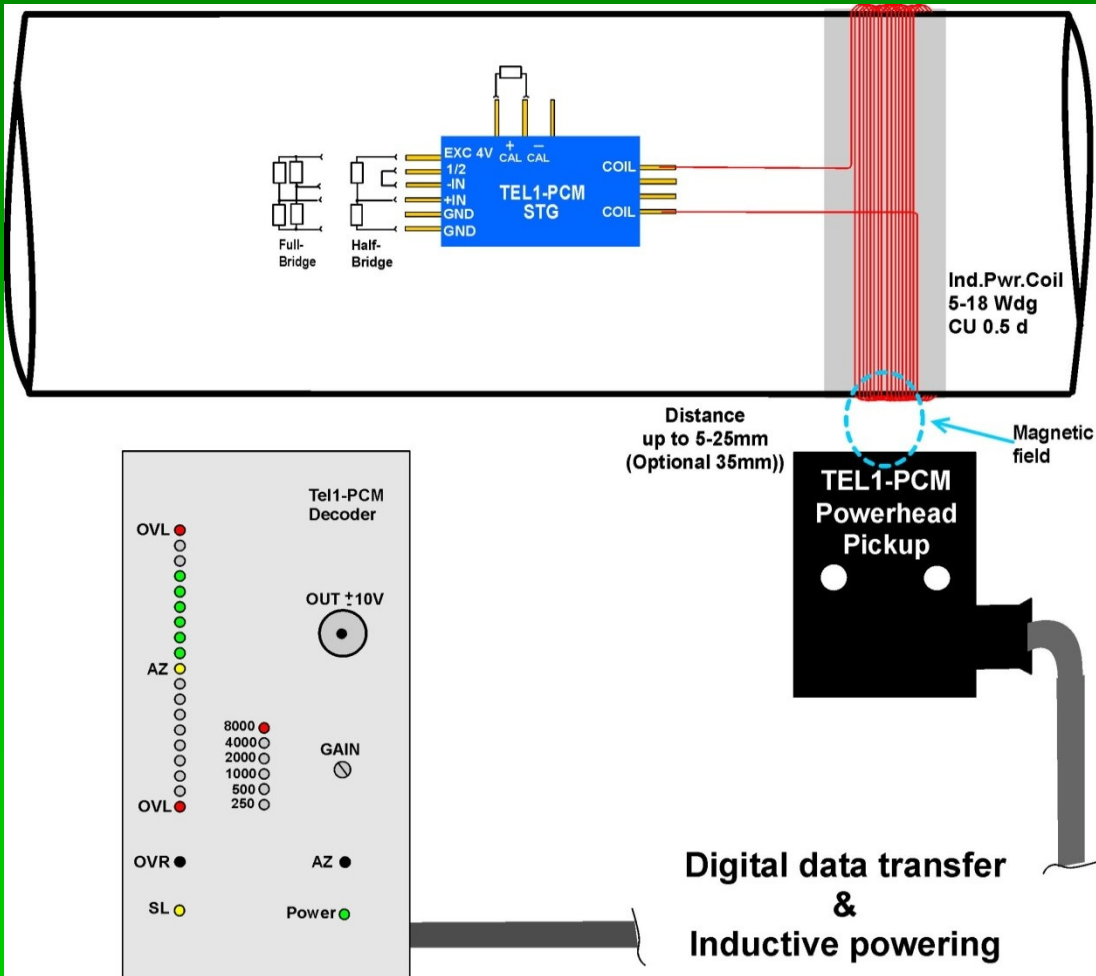

Telemetry Application Examples

TEL1-PCM

Drive shaft of ship engine



Telemetry Application Examples

TEL1-PCM

Torque measurement drive pipe-shaft

KMT

kmt-gmbh.com

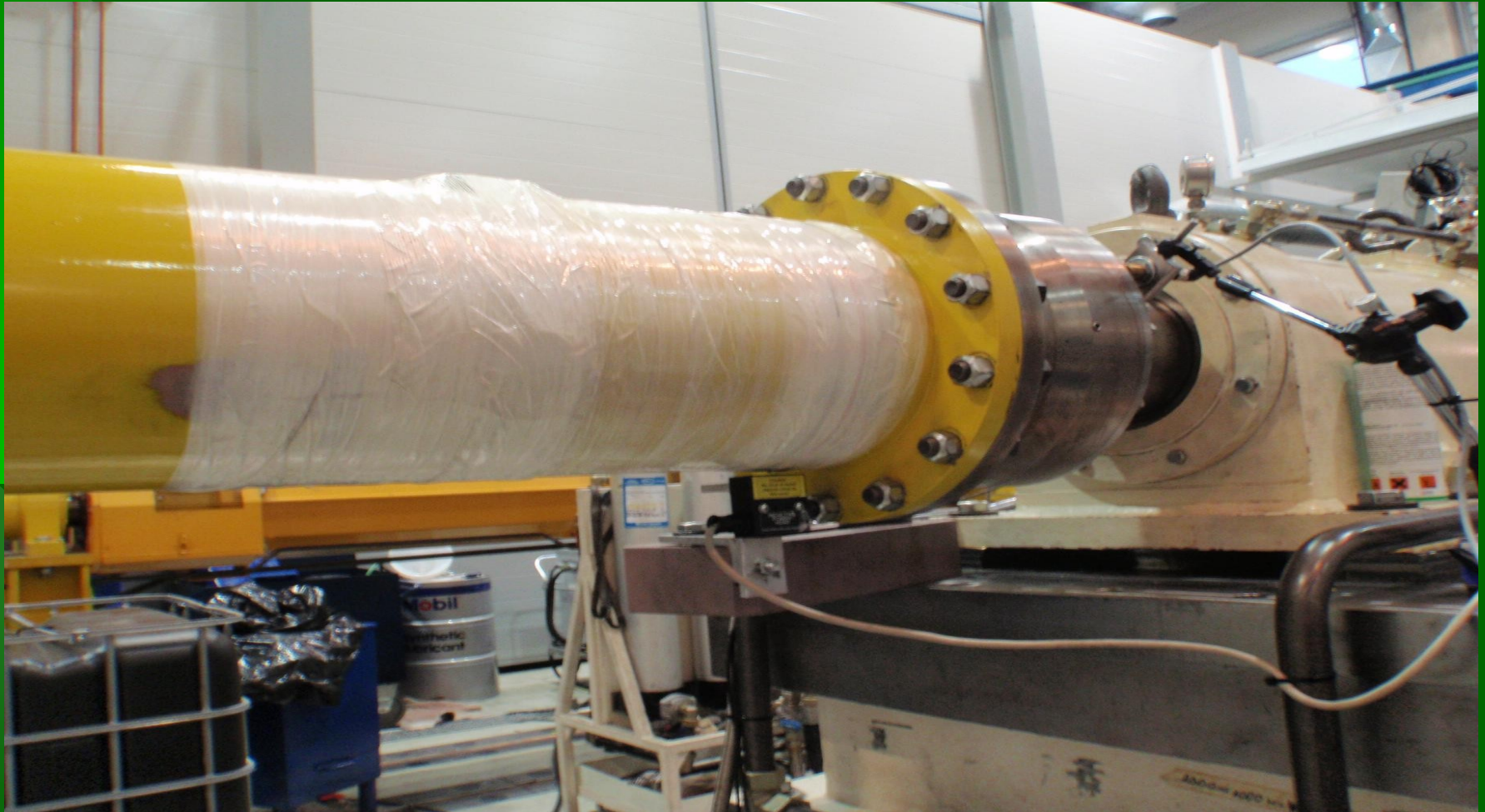

Telemetry Application Examples

TEL1-PCM

Torque measurement of large gears drive shaft

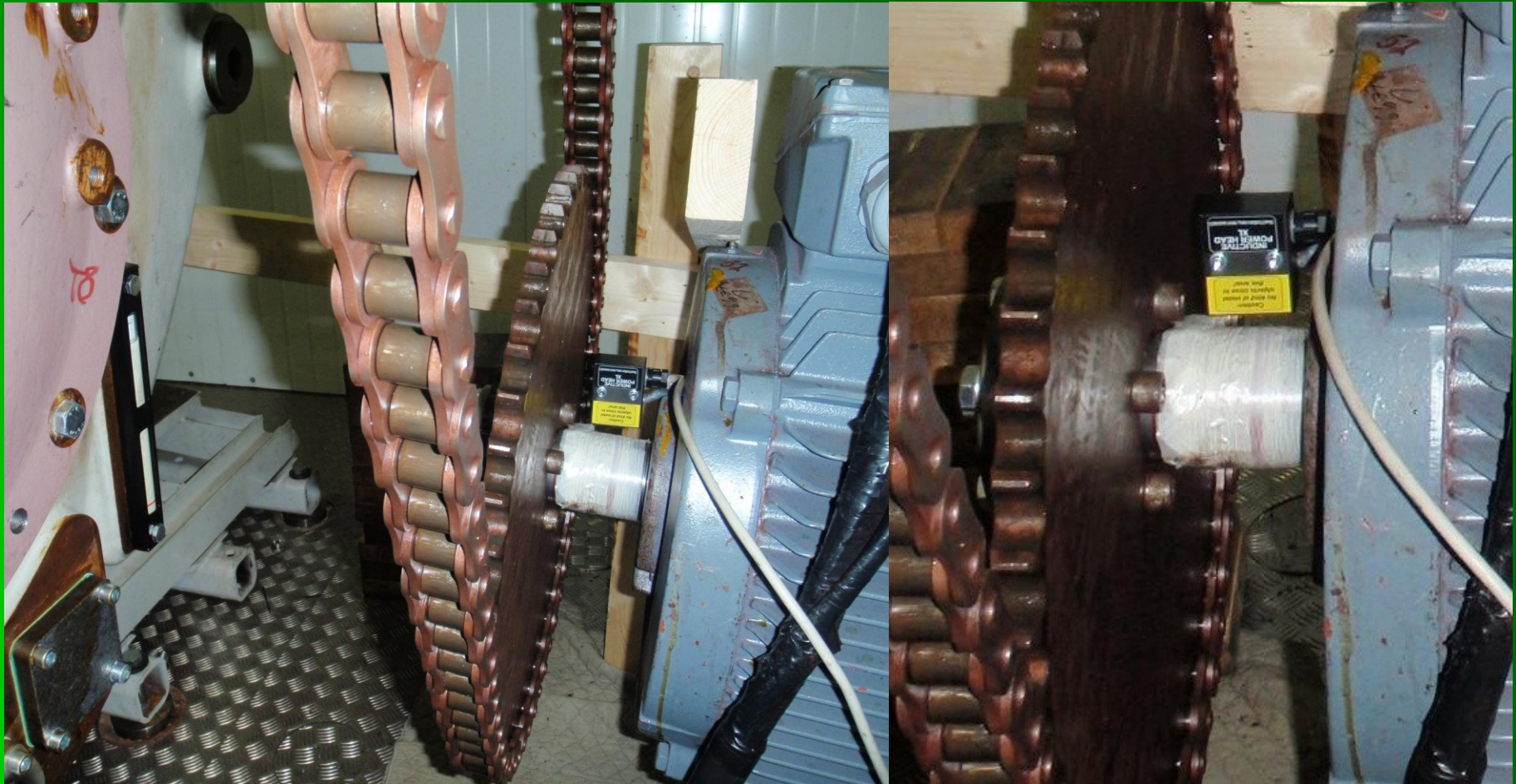

Telemetry Application Examples

TEL1-PCM

Drive shaft of earth-moving equipment



Telemetry Application Examples

TEL1-PCM

Drive shaft of earth-moving equipment

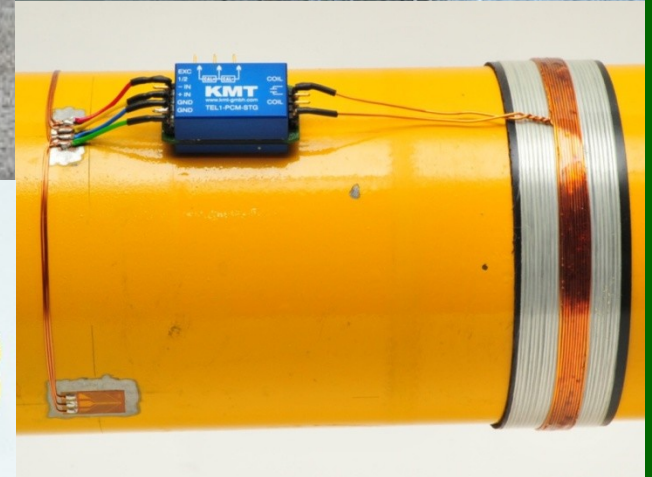

Telemetry Application Examples

TEL1-PCM

Drive shaft of windmill



Telemetry Application Examples

TEL1-PCM

Force measurement at railway wheel axis



Telemetry Application Examples

TEL1-PCM

Drive shaft of hydropower plant

KMT

kmt-gmbh.com

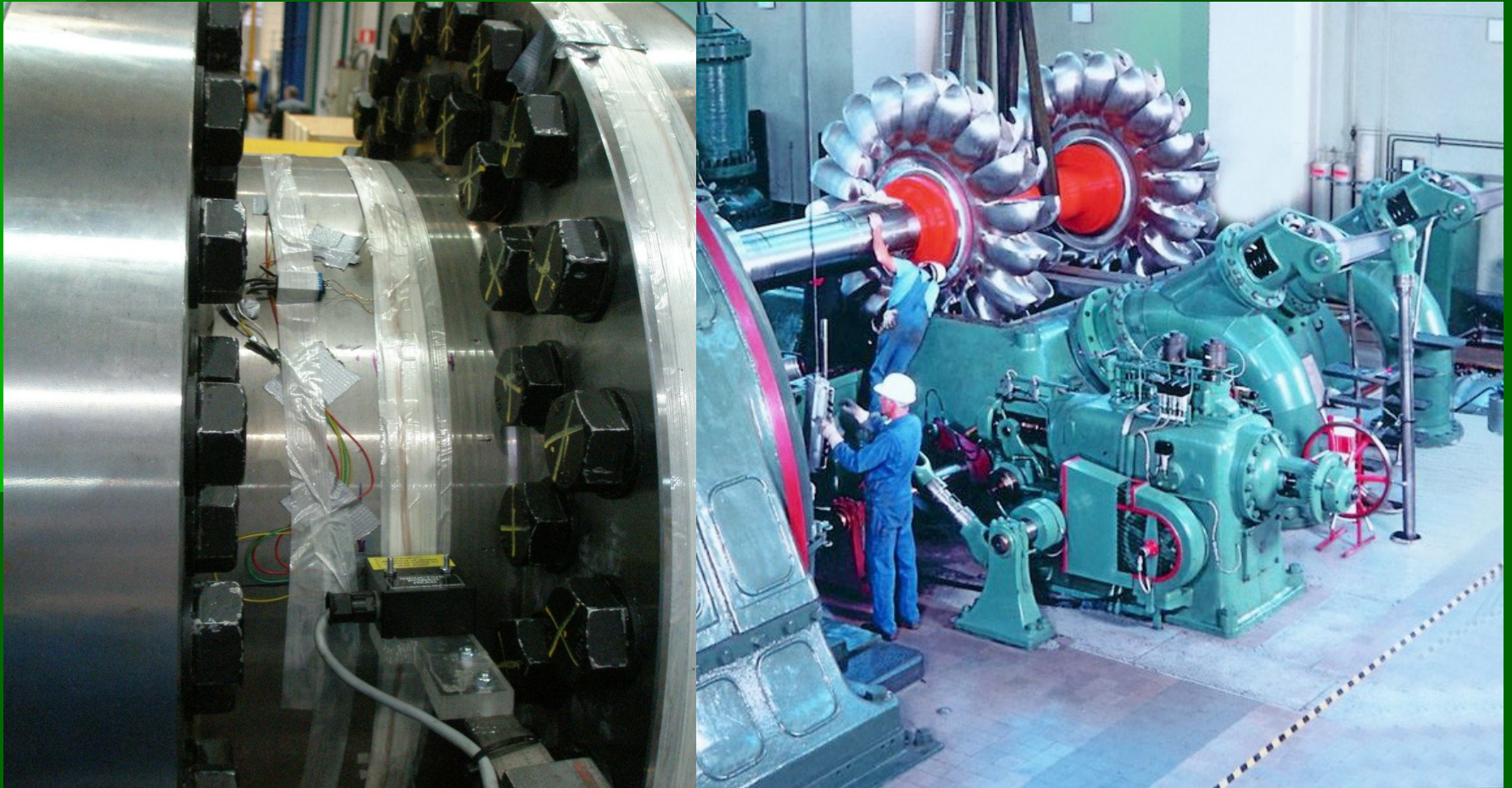

Telemetry Application Examples

TEL1-PCM

Drive shaft of gear test bend

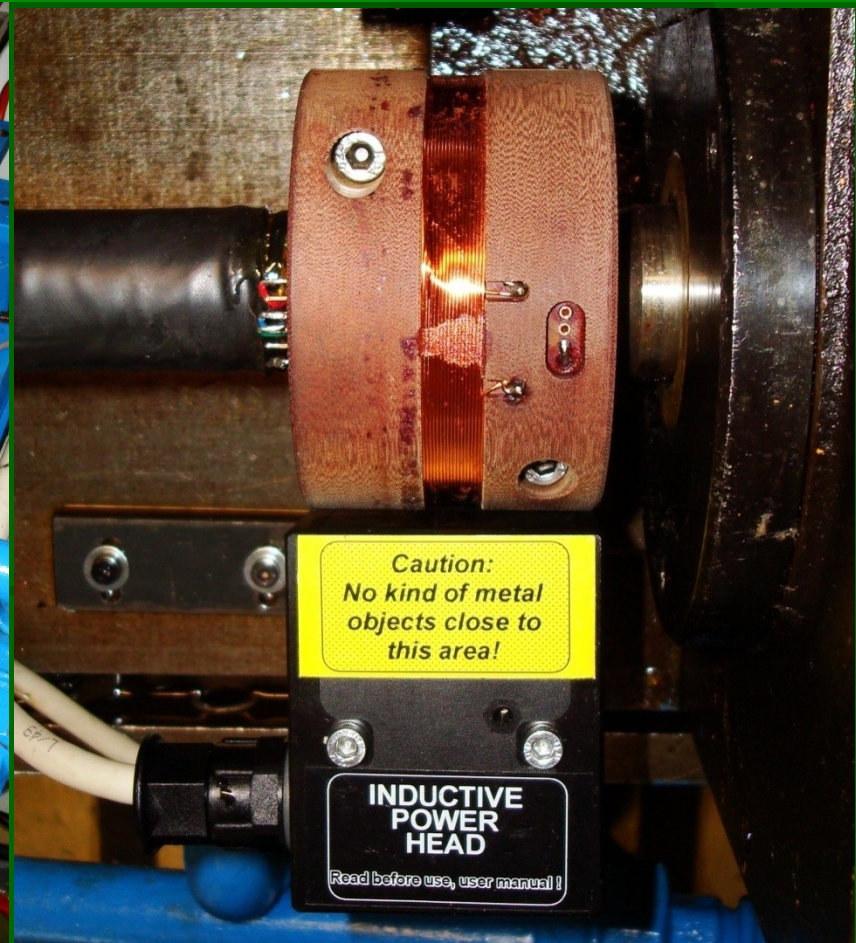
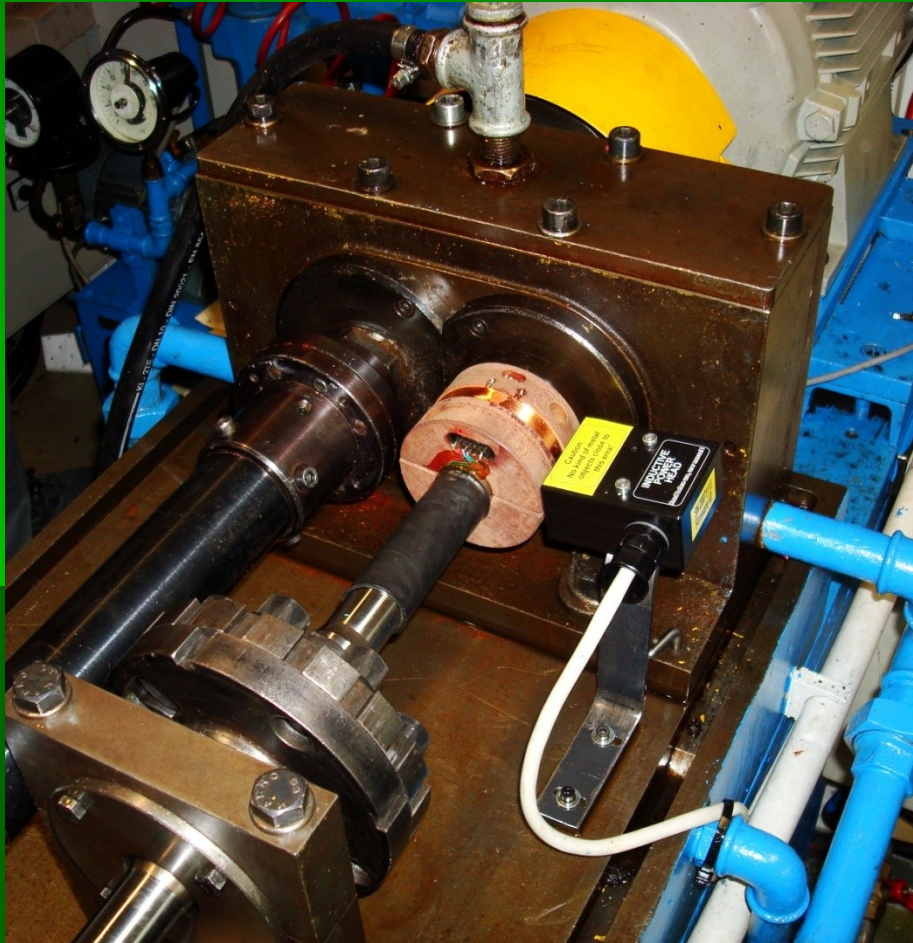

Telemetry Application Examples

TEL1-PCM

Force measurement of car belt pulley

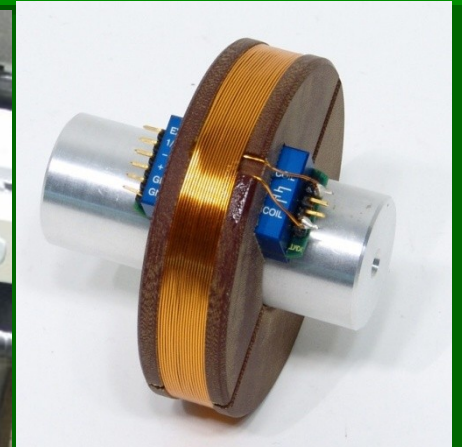
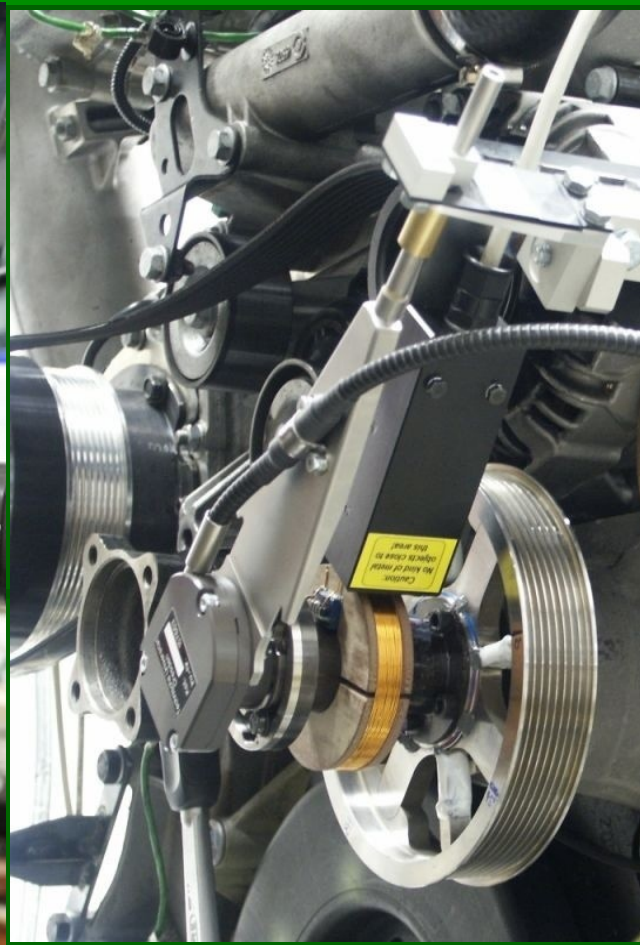
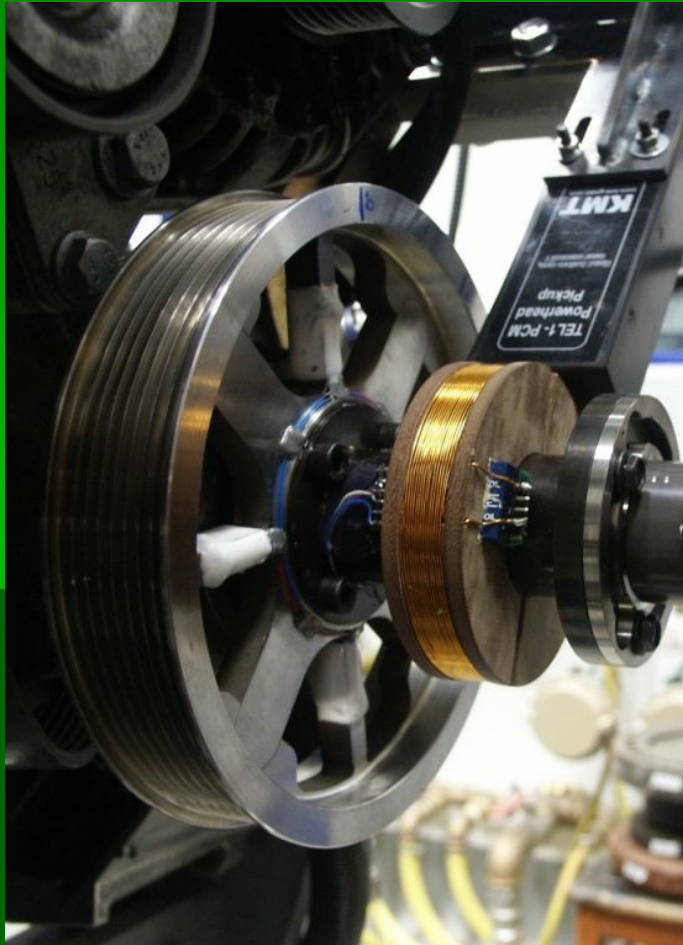

Telemetry Application Examples

TEL1-PCM

Temperature measurement of bearing

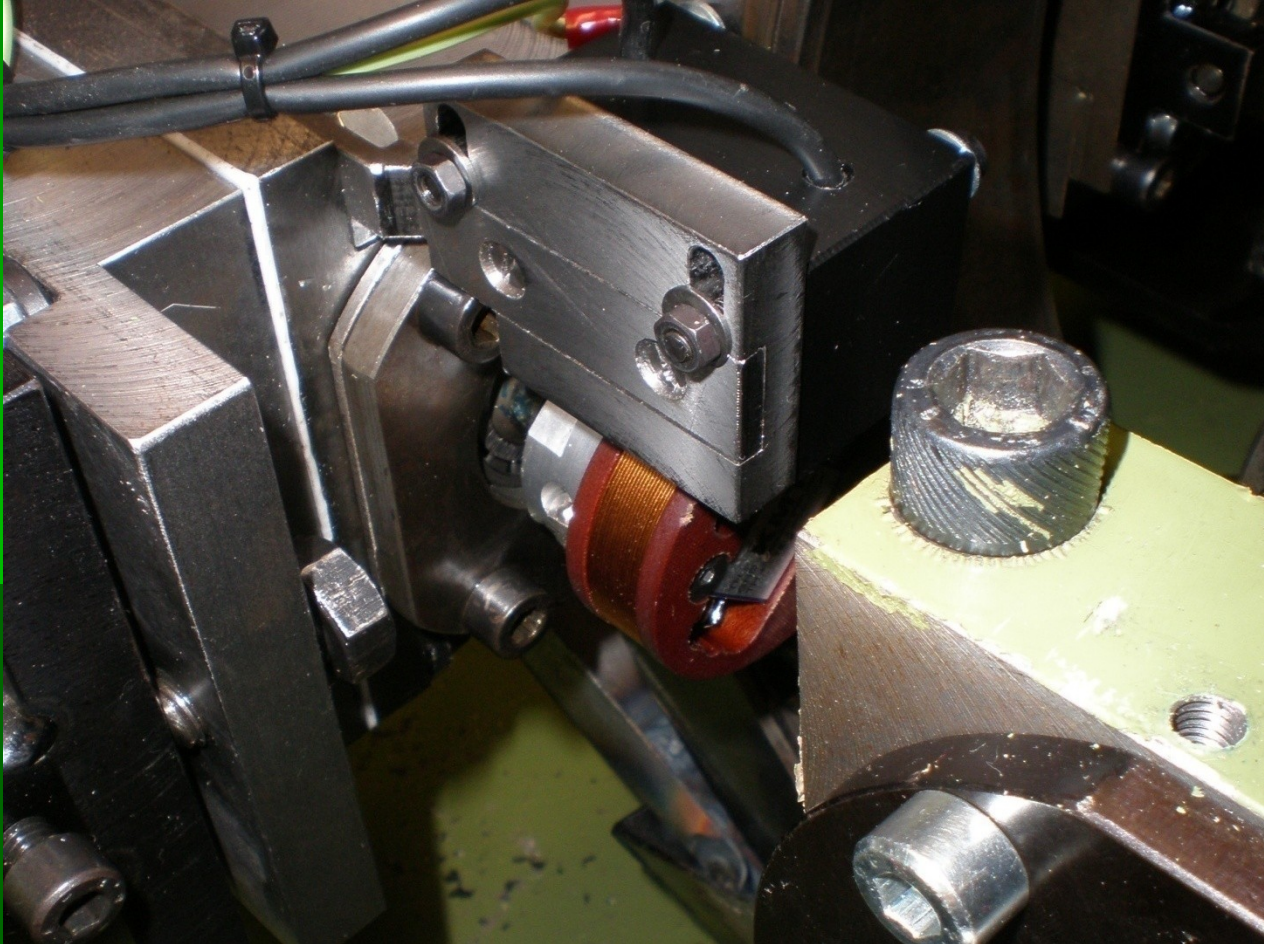

Telemetry Application Examples

Some TEL1-PCM-Referencys



Thank you for your attention!

KMT- Kraus Messtechnik GmbH
Martin Kraus – Sales Manager
Gewerbering 9
D-83624 Otterfing - Germany
Tel. +49-8024-48737
Fax +49-8024-5532
Email: info@kmt-gmbh.com
Web: www.kmt-gmbh.com

